

CVUN-1000AC/5-BEJA-Z

Old Type Designation: CV05C-1000UCD

Specifications	
Capacity C_{max} (nominal)	1000 pF
Capacity C_{min} (nominal)	100 pF
Voltage (Peak Test U_{pt} / Peak Working U_{pw})	5 kV / 3 kV
Capacity Tolerance (linear Range)	10%
Max. Current I_{max} at 13.56 MHz with	89 Arms
Conduction Cooling	20 W
Self Inductance	≤ 9 nH
Capacitance per turn	81.1 pF/turn
Torque	≤ 0.2 Nm
Net Weight	0.58 kg

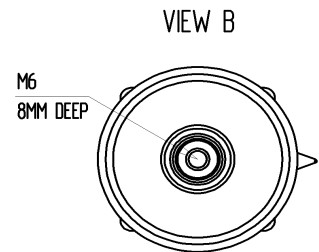
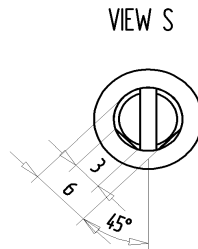
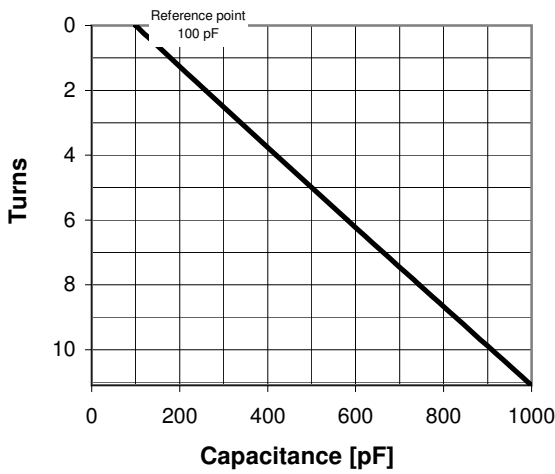
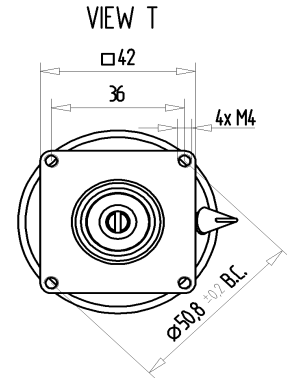

I_{max} at 25 °C ambient and 125 °C surface temp. for convection and conduction (20 W) cooling

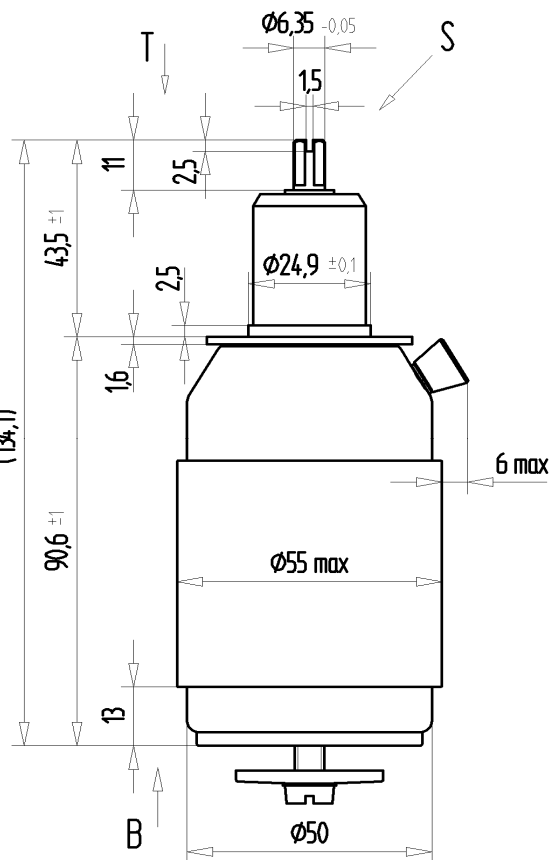
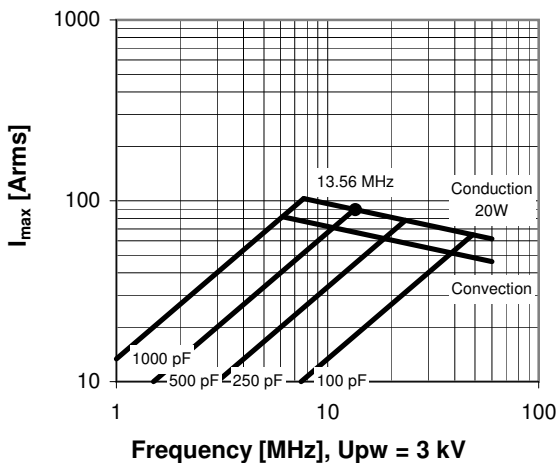

Turns	Nominal Capacitance [pF]	Tolerance
0.0	100.0	0%
2.0	259.0	10%
4.0	418.9	10%
6.0	581.8	10%
8.0	744.7	10%
11.1	1000.0	10%

Mechanical stop at < 100 pF at ~ -0.5 turns
Mechanical stop at > 1000 pF at ~ 11.2 turns

Self inductance and resonance frequency

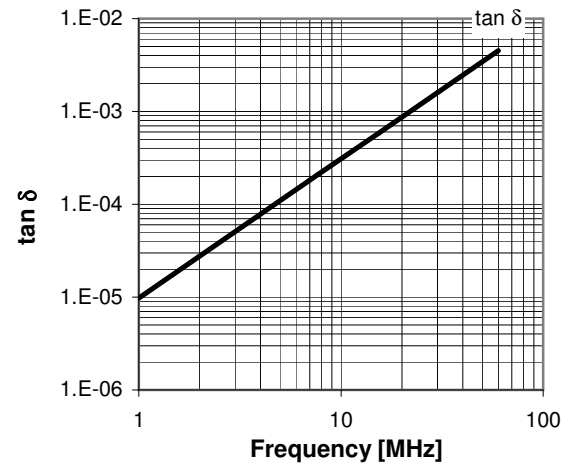
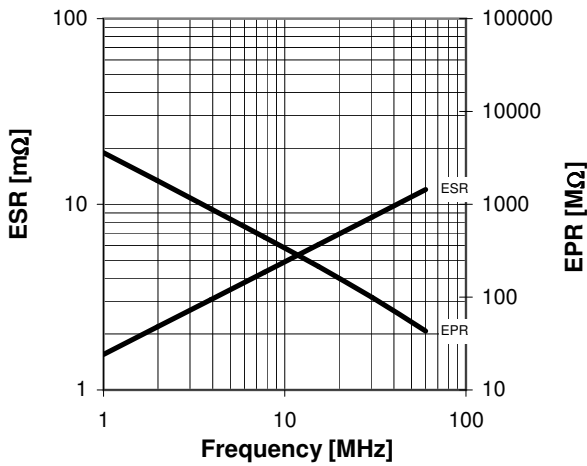
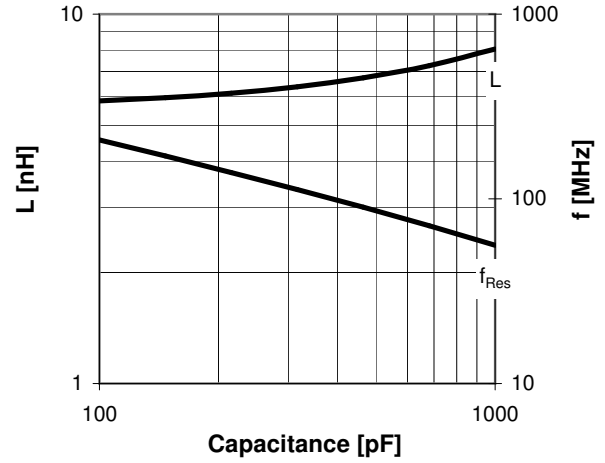

Special Features:

Special Series Features