

CVLA-1600BW/40-ABE-HN

Old Type Designation: CV3W-1600EB

Specifications

Capacity C_{max} (nominal)	1600 pF
Capacity C_{min} (nominal)	100 pF
Voltage (Peak Test U_{pt} / Peak Working U_{pw})	40 kV / 24 kV
Capacity Tolerance (linear Range)	2%
Max. Current I_{max} at 13.56 MHz with	633 Arms
Water Cooling	25 l/min
Self Inductance	≤ 36 nH
Capacitance per turn	35.8 pF/turn
Torque	≤ 1.5 Nm
Net Weight	22 kg

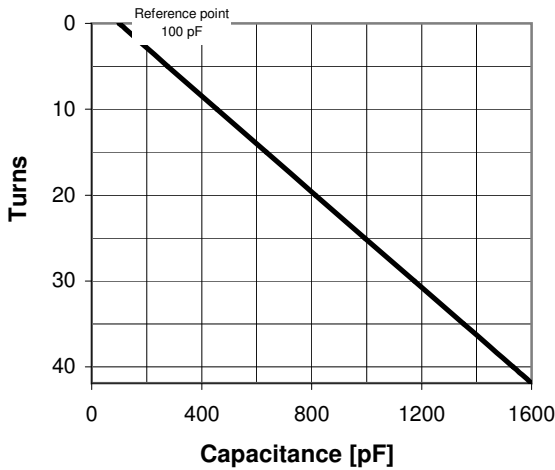
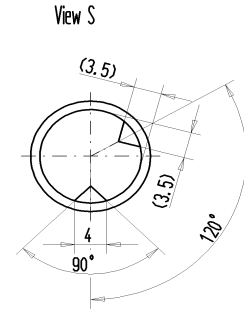

I_{max} for 25 l/min water cooling; max. water temp. at inlet: 70°C;
fixed end has to be cooled with min. 50 W

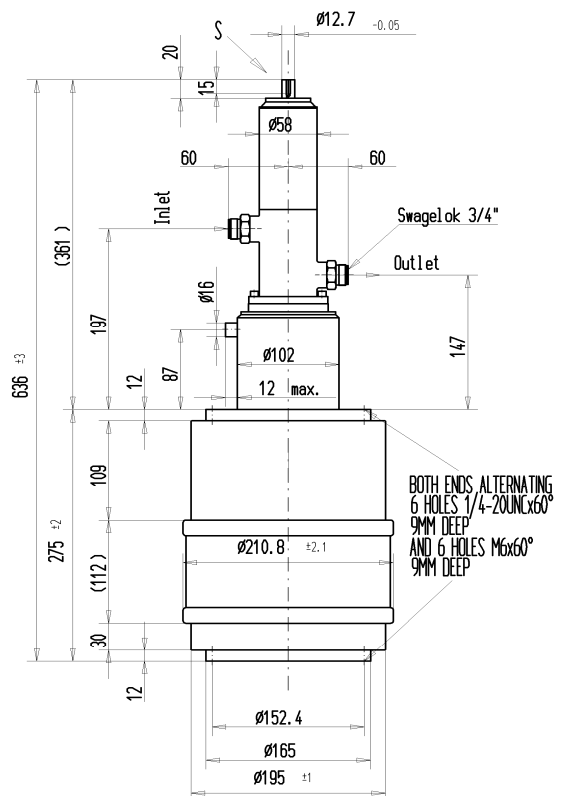
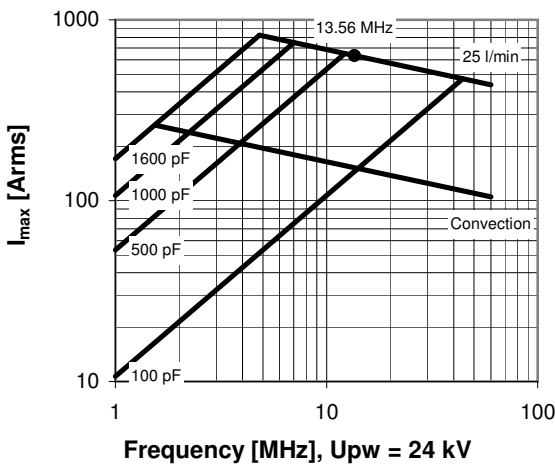

Turns	Nominal Capacitance [pF]	Tolerance
0.0	100.0	0%
5.0	276.1	2%
10.0	455.4	2%
15.0	634.8	2%
20.0	814.3	2%
25.0	993.8	2%
30.0	1173.3	2%
35.0	1352.7	2%
40.0	1532.2	2%
41.9	1600.0	2%

Mechanical stop at < 100 pF at ~ -1.5 turns
Mechanical stop at > 1600 pF at ~ 42.2 turns

Self inductance and resonance frequency

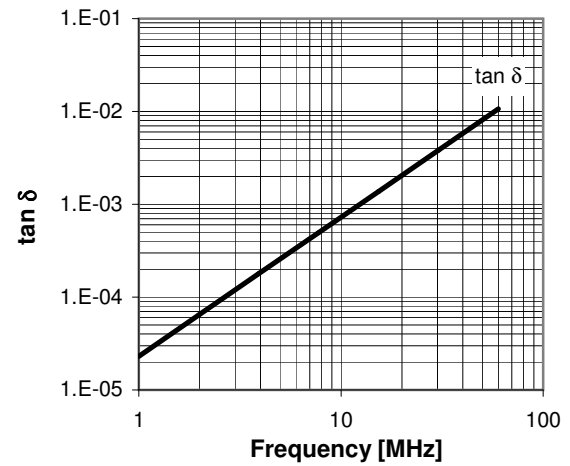
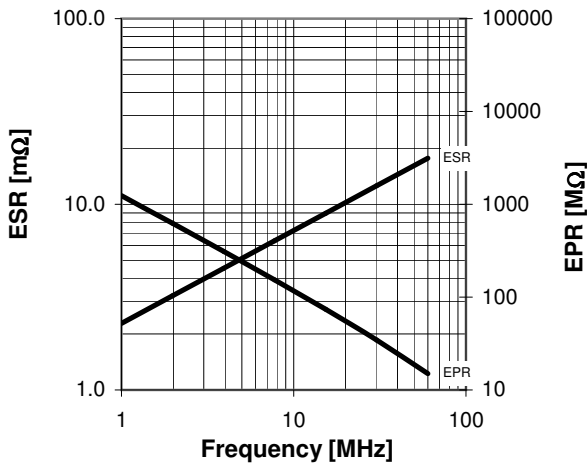
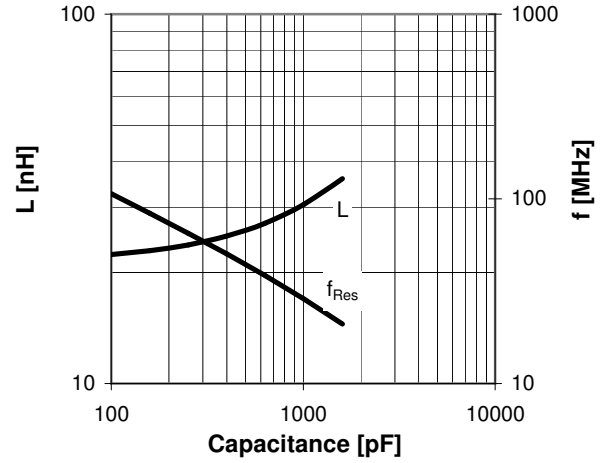

Special Features:

Special C-Curve / Special Capacity Tolerance,
Turbulence Cooling