

CVLA-1000CW/50-ABE-N

Old Type Designation: CV3W-1000JB

Specifications

Capacity C_{max} (nominal)	1000 pF
Capacity C_{min} (nominal)	100 pF
Voltage (Peak Test U_{pt} / Peak Working U_{pw})	50 kV / 30 kV
Capacity Tolerance (linear Range)	10%
Max. Current I_{max} at 13.56 MHz with	843 Arms
Water Cooling	25 l/min
Self Inductance	≤ 39 nH
Capacitance per turn	35.6 pF/turn
Torque	≤ 1.5 Nm
Net Weight	18 kg

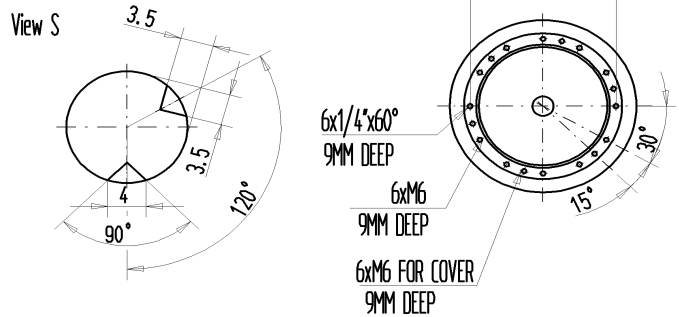
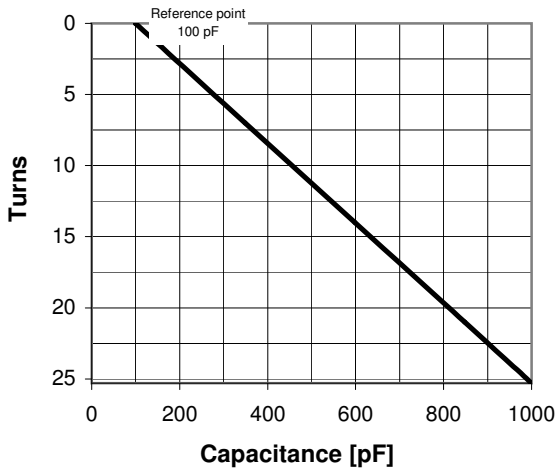

I_{max} for 25 l/min water cooling; max. water temp. at inlet: 70°C;
fixed end has to be cooled with min. 50 W

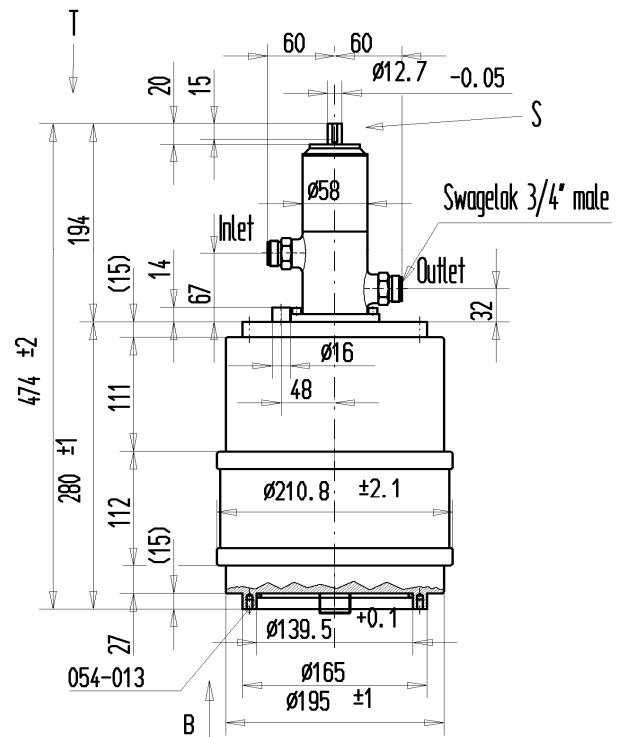
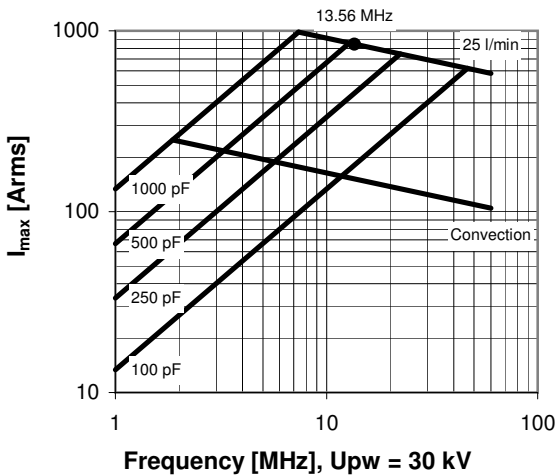

CVLA-1000CW/50-ABE-N

Old Type Designation: CV3W-1000JB

Turns	Nominal Capacitance [pF]	Tolerance
0.0	100.0	0%
7.0	348.3	10%
14.0	598.1	10%
21.0	847.8	10%
25.3	1000.0	10%

Mechanical stop at < 100 pF at ~ -1.1 turns
Mechanical stop at > 1000 pF at ~ 25.5 turns

Self inductance and resonance frequency

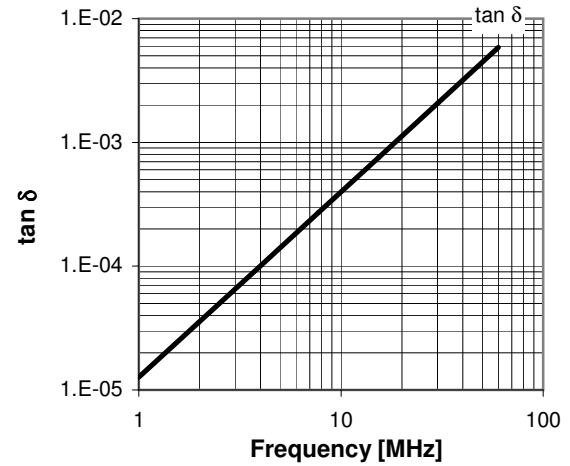
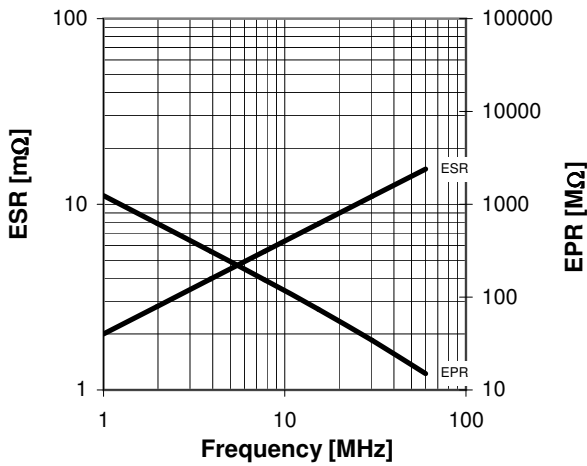
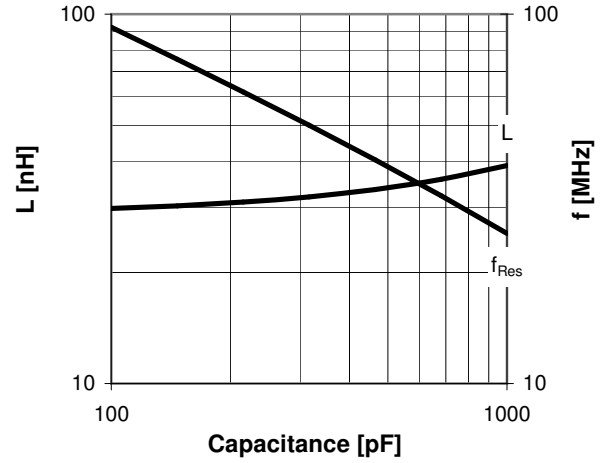

Special Features:

Turbulence Cooling