

CVDU-650EC/5-DEFZ

Old Type Designation: CV05C-650NB

Specifications	
Capacity C_{max} (nominal)	650 pF
Capacity C_{min} (nominal)	8 pF
Voltage (Peak Test U_{pt} / Peak Working U_{pw})	5 kV / 3 kV
Capacity Tolerance (linear Range)	10%
Max. Current I_{max} at 13.56 MHz with	63 Arms
Conduction Cooling	20 W
Self Inductance	≤ 8 nH
Capacitance per turn	78.6 pF/turn
Torque	≤ 0.15 Nm
Net Weight	0.4 kg

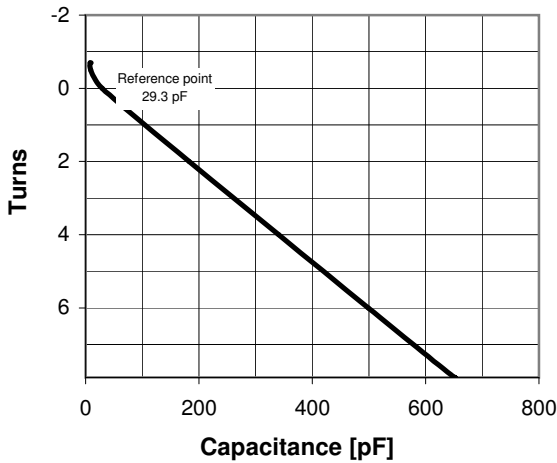
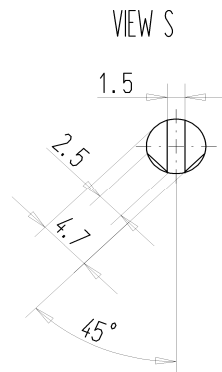
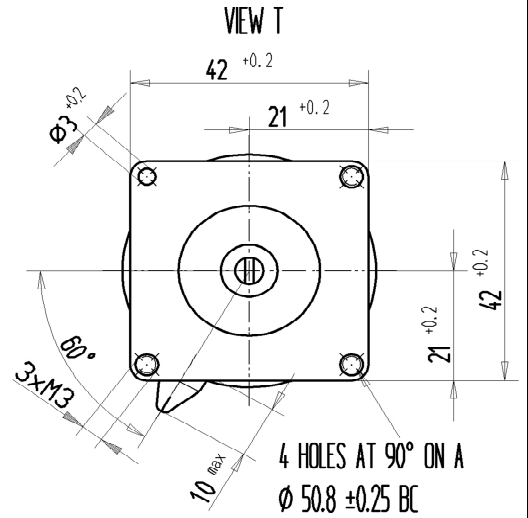

I_{max} at 25°C ambient and 125°C surface temp. for convection and conduction (20 W) cooling

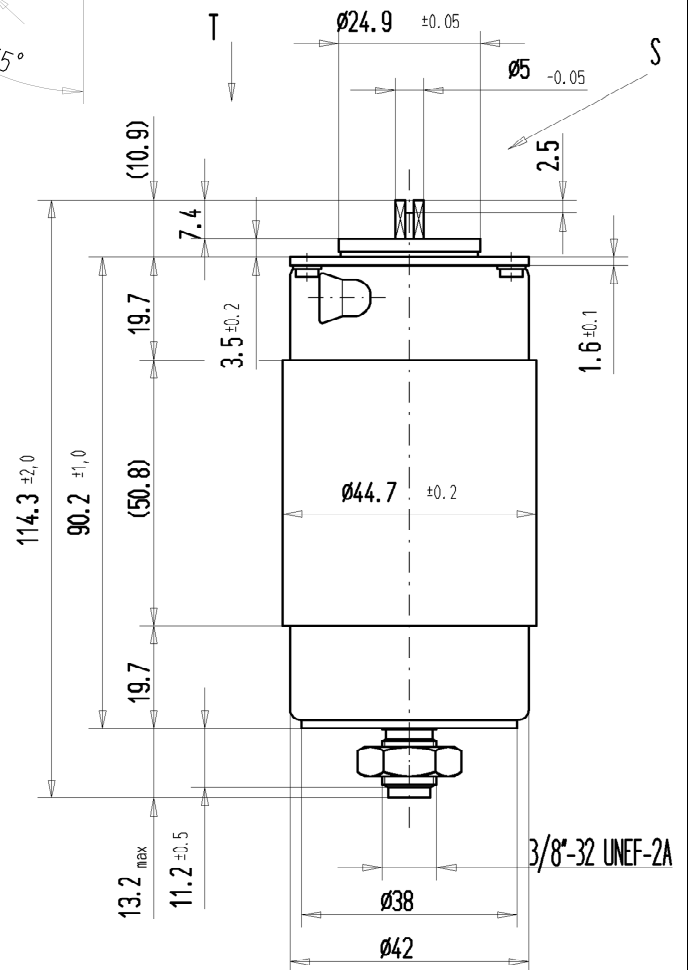
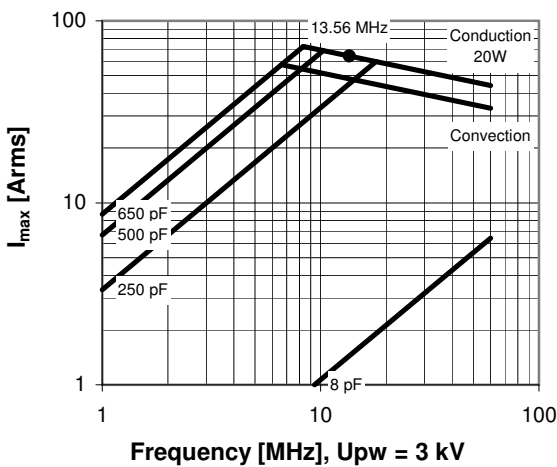

Subject to change without prior notice

Note: Technical information in Service Bulletin SB-52 must be considered

Turns	Nominal Capacitance [pF]	Tolerance
-0.7	8.0	10%
-0.5	9.3	10%
0.0	29.3	0%
2.0	182.3	10%
4.0	340.7	10%
6.0	499.1	10%
7.9	650.0	10%

Mechanical stop at < 8 pF at ~ -1.4 turns
Mechanical stop at > 650 pF at ~ 8 turns

Self inductance and resonance frequency

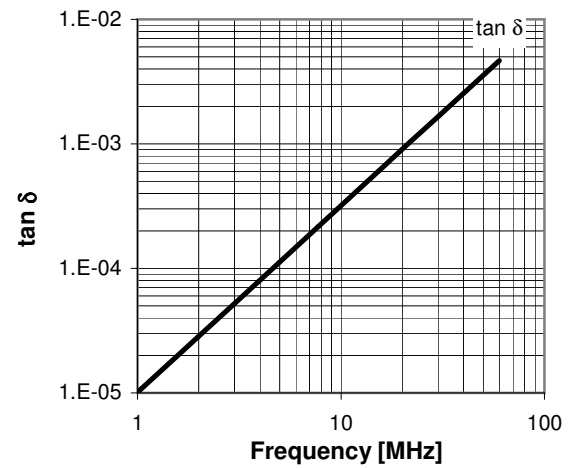
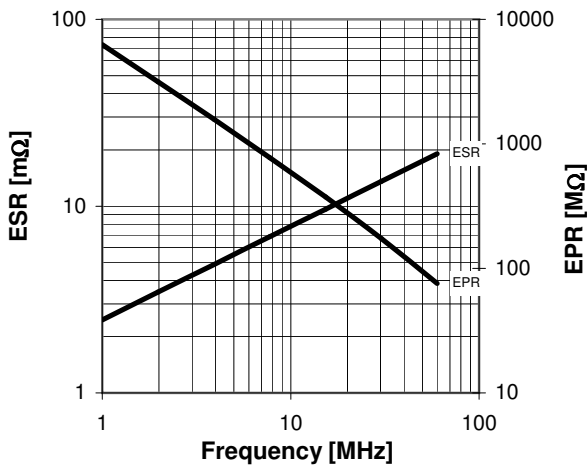
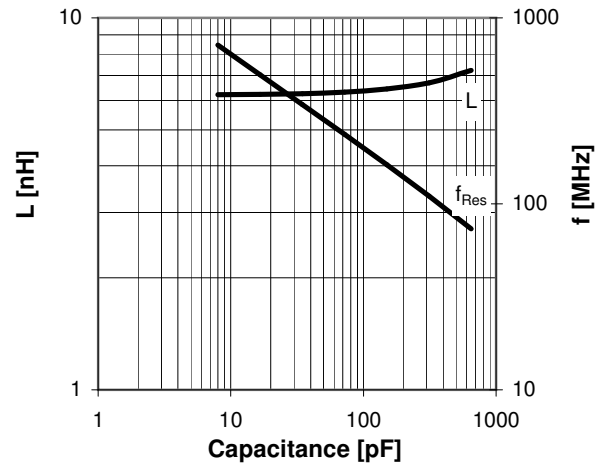

Subject to change without prior notice

Note: Technical information in Service Bulletin
SB-52 must be considered